

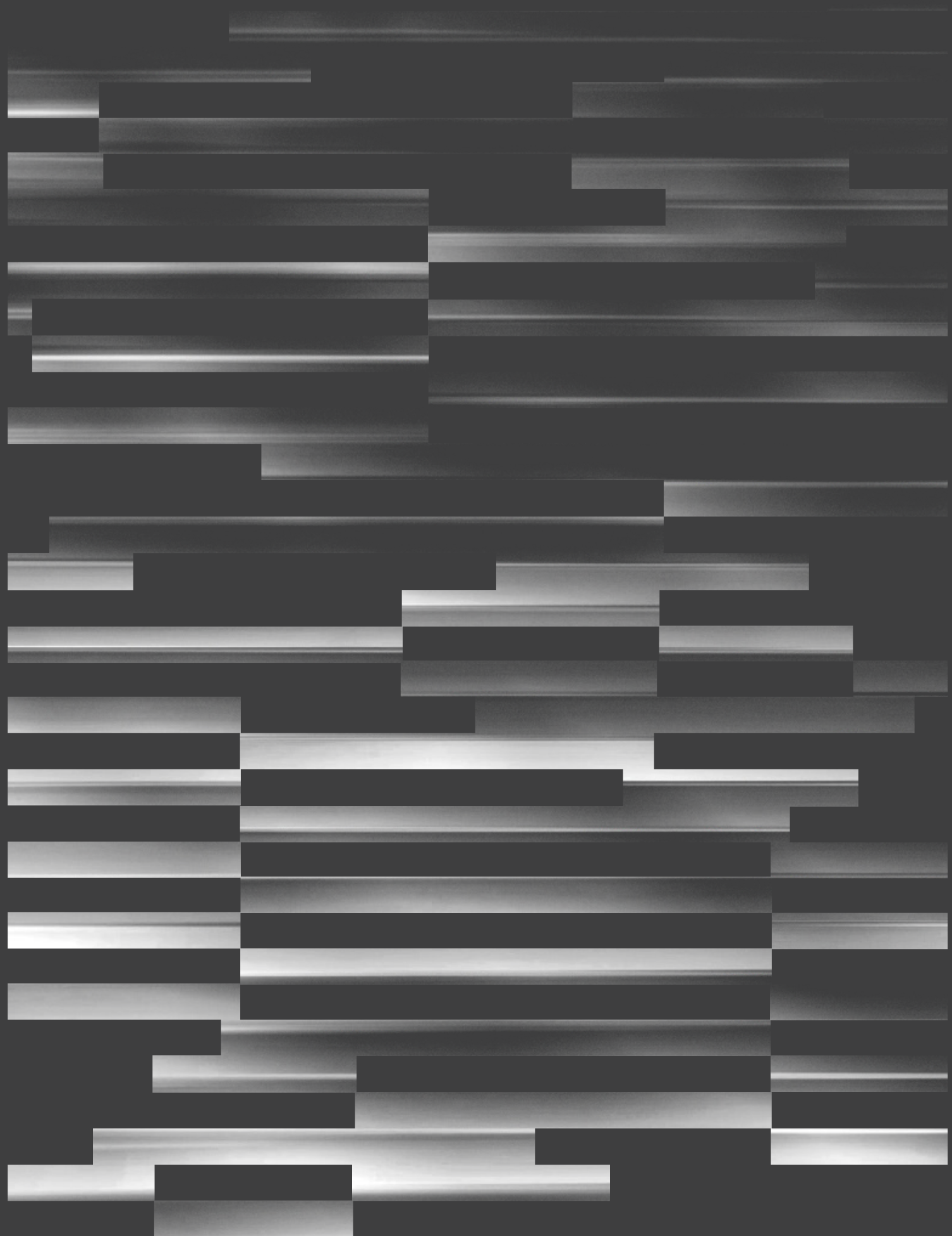

PRODUCT CATALOGUE



2020

EKOLUKA KEY
Reliable partner for mutual success

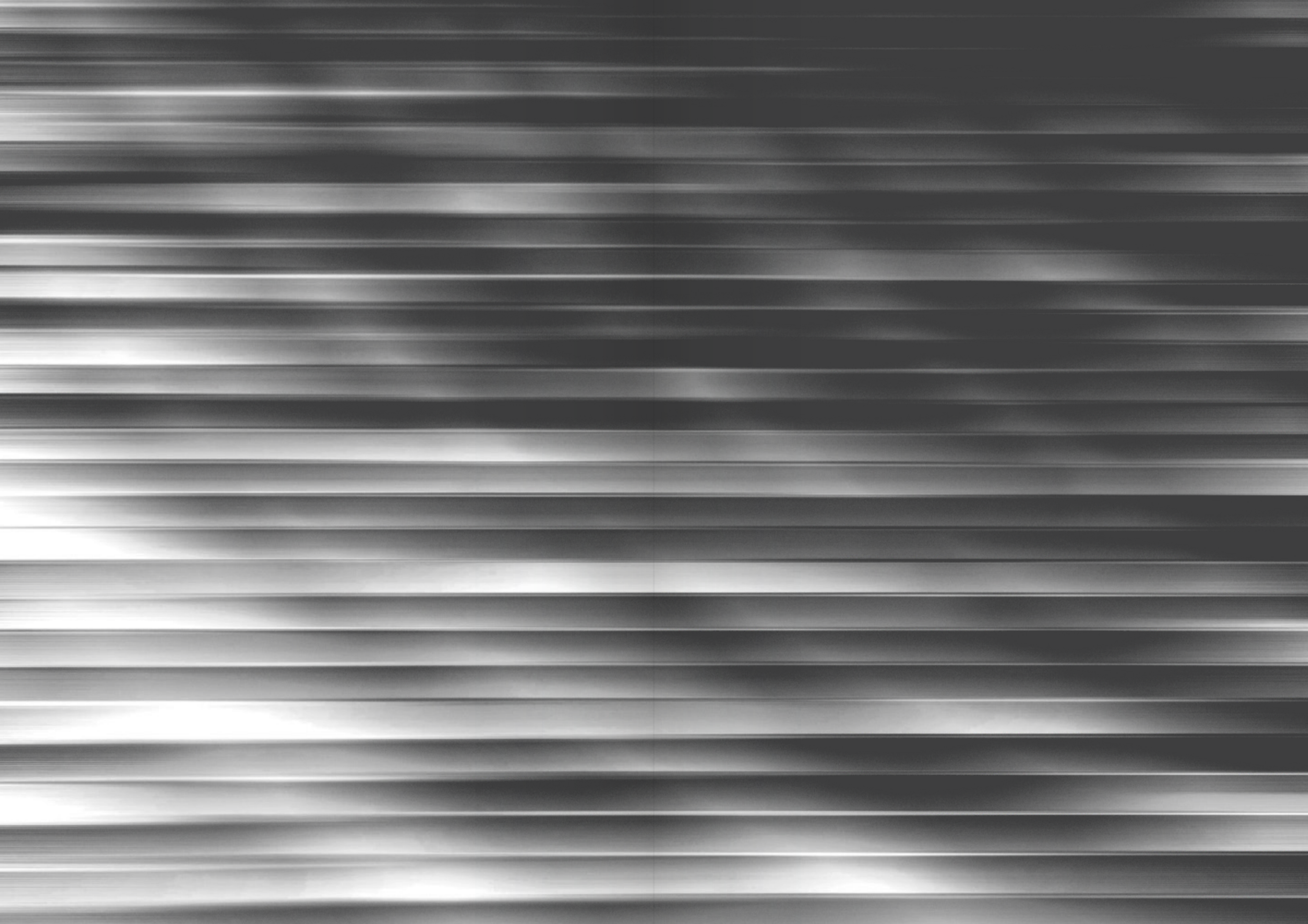

**PRODUCT
CATALOGUE**



2020

ABOUT US

Based on the positive experience and achieved business results in the past period, in order to realize more ambitious goals and create an ambience for even more successful business relations with existing and new business partners, EKOLUKA KEY LTD. with special pleasure presents a new catalog of products in the field of rolling shutters from our commercial offer.

By selecting renowned manufacturers with whom we have long-term and successful business cooperation, we are able to offer on market a continuous and stable supply of a wide range of products whose quality and affordable prices meet strict market criteria.

Over the years EKOLUKA KEY LTD., has gained the trust of a large number of customers, which has enabled us to build a recognizable and well-accepted image on the market and become one of the leading suppliers of aluminum and PVC slats, aluminum and PVC profiles, aluminum and PVC boxes, tubular motors, raw materials for roll-up, plisse and fixed insect screens as well as other accompanying equipment and accessories.

A large number of existing customers and business partners through many years of successful commercial cooperation with the company EKOLUKA KEY LTD., was introduced to our business policy, which is primarily reflected in constant improvement, fostering good business relationships with customers and innovative introduction of new products in accordance with the strict requirements of the market.

Attention of the complete EKOLUKA KEY LTD. team is focused on the maximum satisfaction of the requirements of our customers, achieving the highest possible quality of the products we sell, providing favorable prices, constant expansion of the product range, continuity and stability in supply.

EKOLUKA KEY LTD. wants to believe that this catalog, which is primarily intended for customers, can certainly contribute to even better business cooperation, achieving even better results and higher common business goals.

Your,
EKOLUKA KEY LTD. team





**ROLLING
SHUTTERS**

ALUMINIUM FOAM SLAT
(39mm, 45mm)

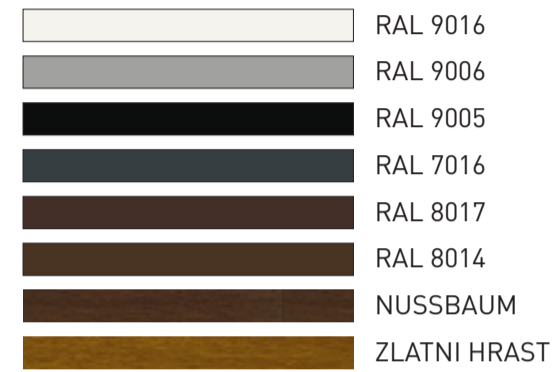
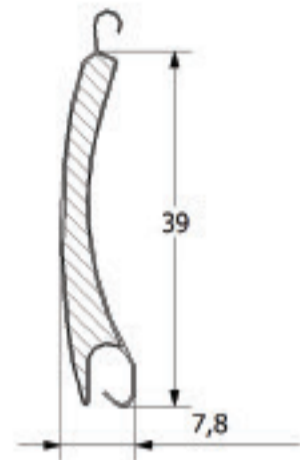

EXTRUDED ALUMINIUM HALF ROUND FRONT BOX
(145mm, 170mm)

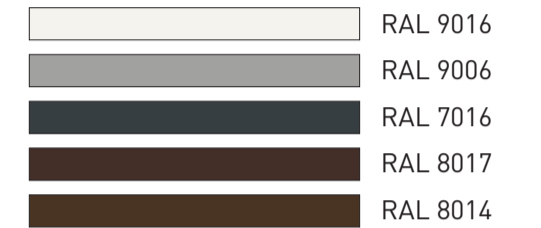
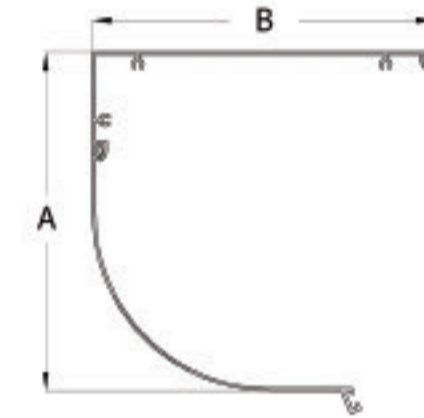

ROLLFORMED ALUMINIUM BOX 45°
(137mm, 165mm)

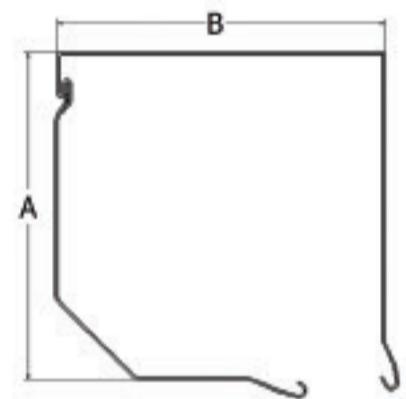

BENDED UNDER FACADE BOX
(180mm, 165mm)

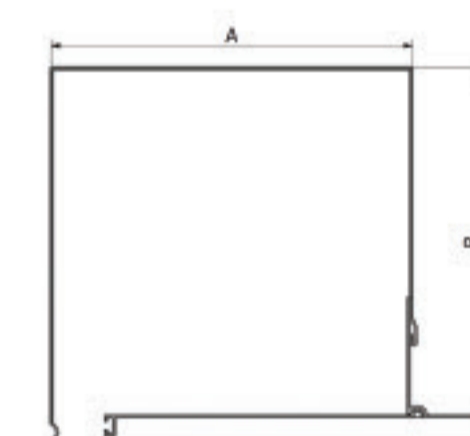

ALUMINIUM HALF ROUND FRONT BOX
(137mm)

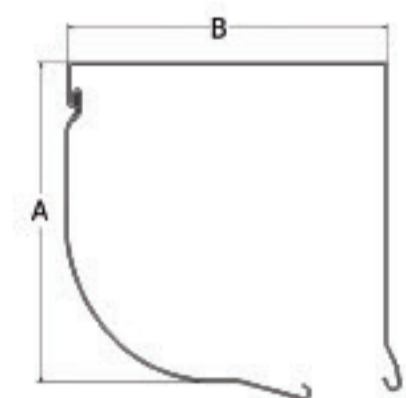



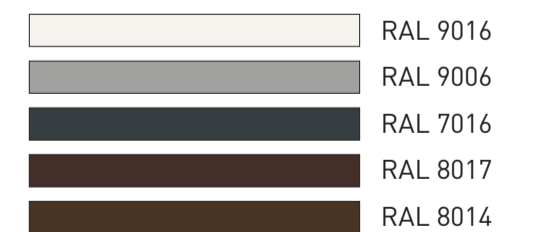
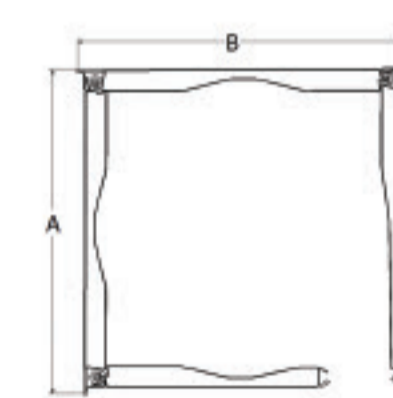
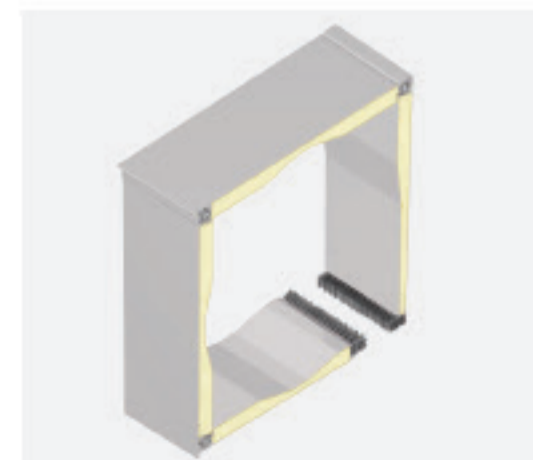

THERMO INSULATED ALUMINIUM BOX
(147mm, 172mm, 195mm)





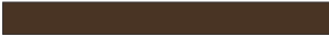



SIDE CAP
(137/45; 165/45)

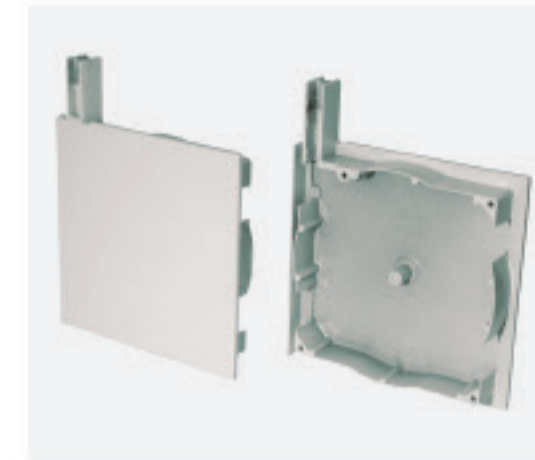

-  RAL 9016
-  RAL 9006
-  RAL 8017
-  RAL 8014
-  RAL 7016



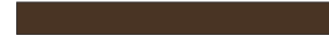

SIDE CAP
(147mm, 172mm, 195mm)



-  RAL 9016
-  RAL 9006
-  RAL 8017
-  RAL 8014
-  RAL 7016

SIDE CAP
(137mm, 145mm, 165mm, 170mm)



-  RAL 9016
-  RAL 9006
-  RAL 8017
-  RAL 8014
-  RAL 7016

SIDE CAP
(172mm, 195mm)



SIDE CAP
(165mm, 180mm)



-  RAL 9016

TIN PLATE FOR FIXING
(172mm, 195mm)



**GUIDE CHANNEL
(53x22)**

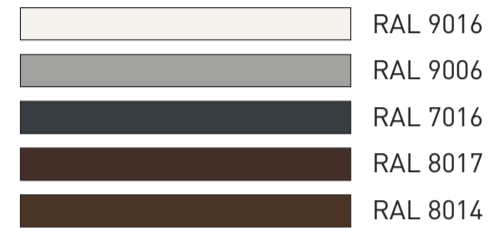

GUIDE CHANNEL

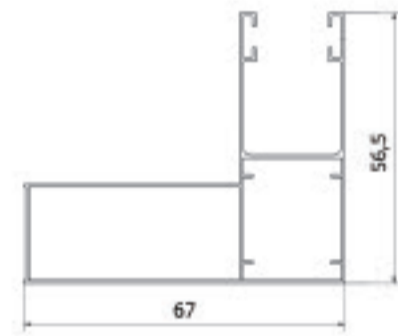
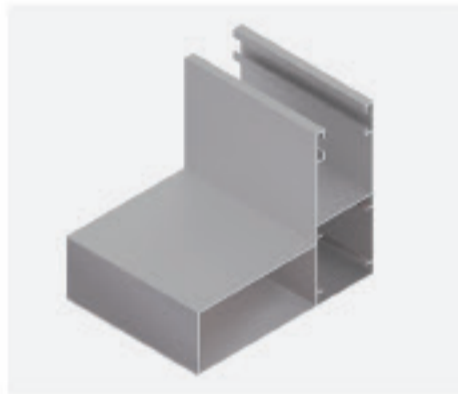

**GUIDE CHANNEL
WITH ANGLE**

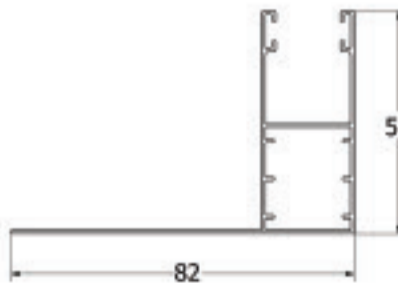
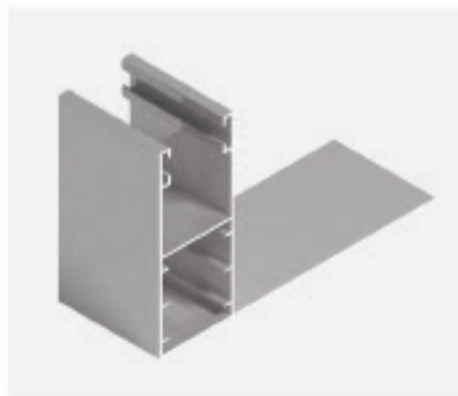

**END SLAT
WITH ONE CHANNEL**

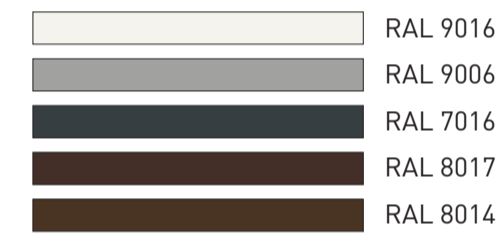

**END SLAT
WITH TWO CHANNELS**

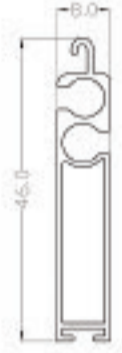

**SQUARE TUBE
(40x20)**

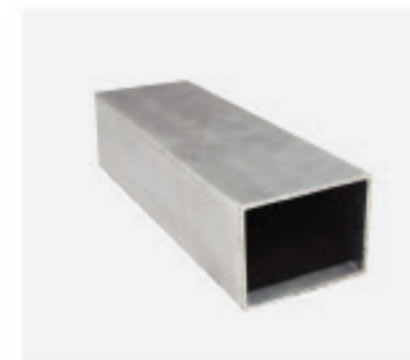

**WINDOWSILL
(150mm, 165mm, 180mm, 195mm,
210mm, 225mm, 240mm)**

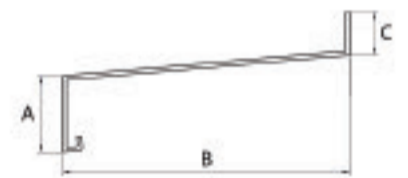

PVC SLAT
(39mm)

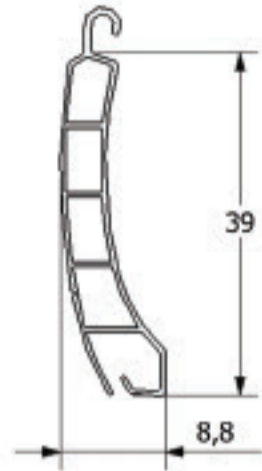

RAL 9016

PVC GUIDE CHANNEL
(53x22)



RAL 9016

PVC BOX
(203x203; 203x153)

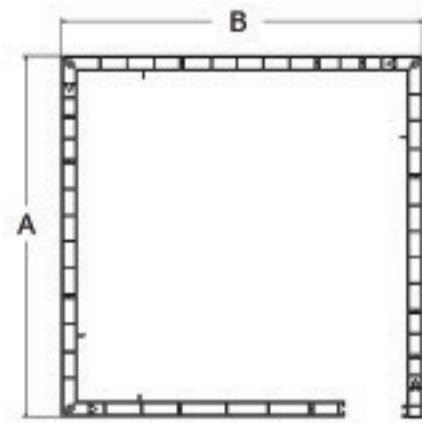
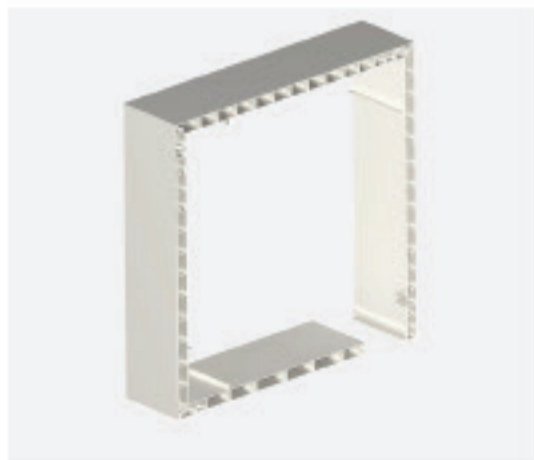

RAL 9016

PVC GUIDE CHANNEL

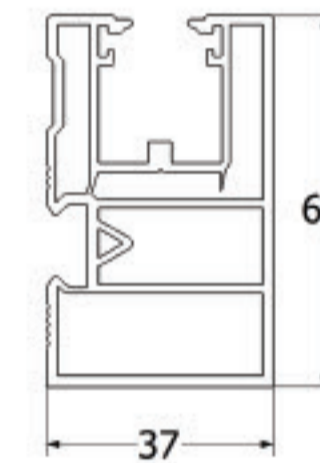
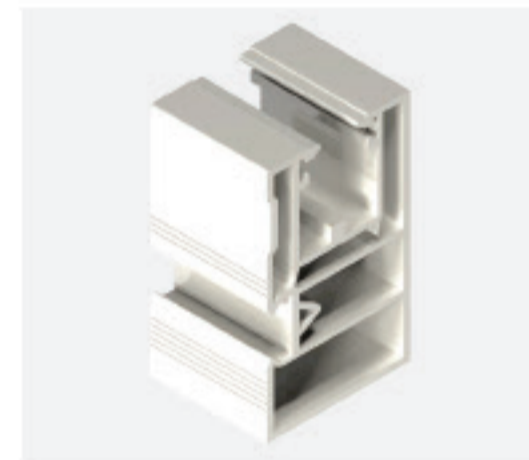

RAL 9016

PVC BOX
(188x188; 218x188
sa i bez L dodatka)

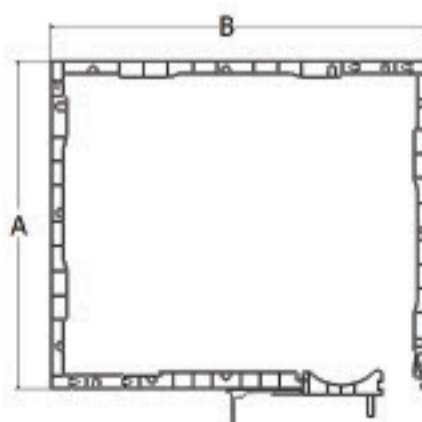

RAL 9016

PVC DOUBLE GUIDE CHANNEL

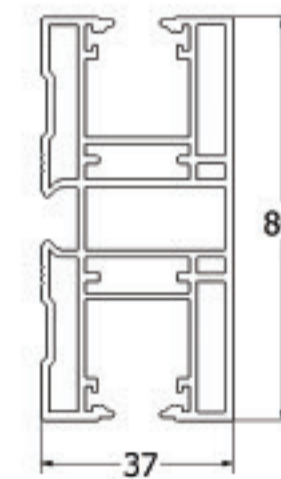
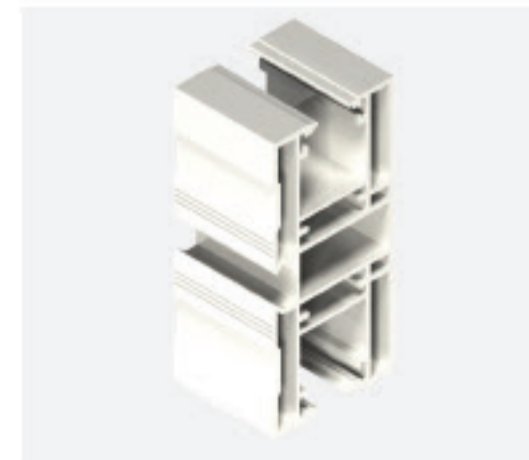

RAL 9016

**BALL BEARING
STEEL BUSHING (28x12)**



**OCTAGONAL GALVANIZED
STEEL AXEL (Ø40; Ø60)**

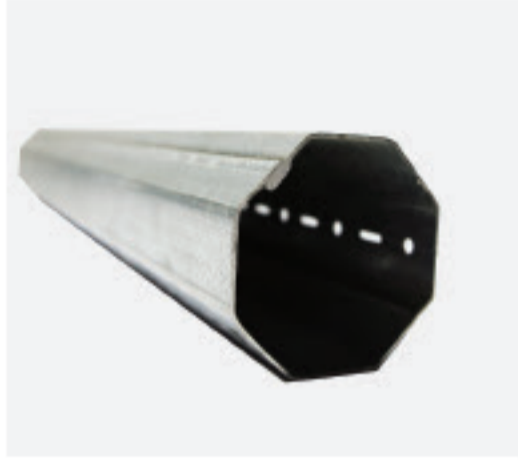

SECURITY SPRING



**CAP
(Ø40/ Ø60)**



STRAP GUIDE



**STOPPER
SHORTER/ LONGER**



**SECURITY SPRING
(130x90x13mm)**



**SECURITY SPRING
(130x90x13mm)**



SPRING



HIDDEN STOPPER



**PLASTIC SIDE LOCK
(39mm, 45mm)**



**PVC PLUG
(Ø10)**



**PULLEY WITH PIN
(40/115 Ø12; 40/140 Ø12)**



**PULLEY
(40/115 Ø12; 40/140 Ø12)**



**CAP WITH PIN
(Ø40)**



**ALUMINIUM GUIDE
CHANNEL PLUG**



**ALUMINIUM SIDE CAP
ENTRY GUIDE**



**NATUROLL SIDE CAP
ENTRY GUIDE
(137, 165)**



STRAP GUIDE



ROPE GUIDE



ROPE FOR COILER
(4mm)



TAPE FOR COILER
(4mm)



SILICONE BRUSH
(4.8x8; 4.8x10; 4.8x12;
6.7x6; 6.7x15; 6.7x18)



END SLAT RUBBER SEAL



COILER WITHOUT TAPE



COILER WITHOUT ROPE



ROPE COILER
(5m)



TAPE COILER
(5m, 6m)



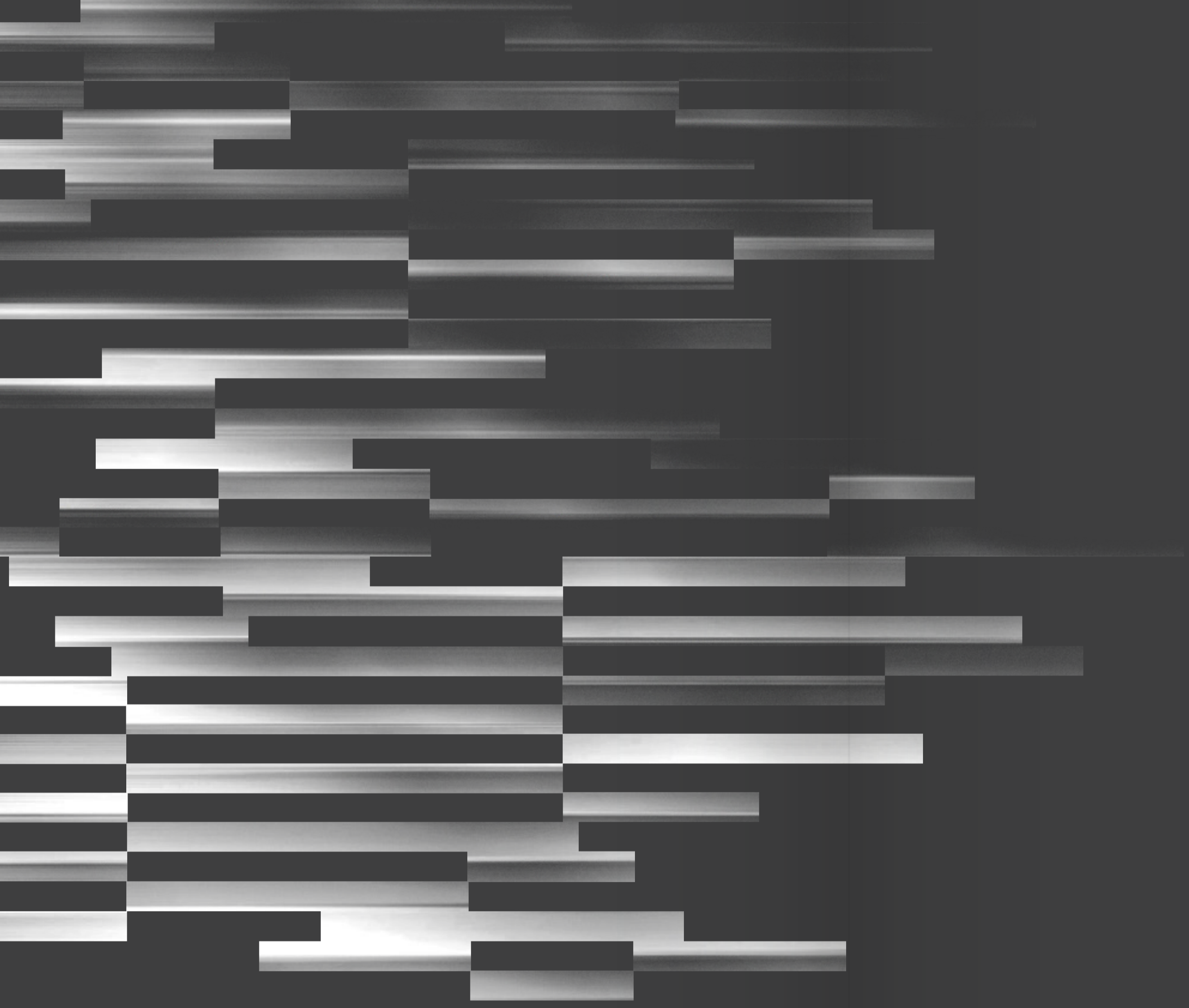

**ROLLER
SHUTTER
DOORS**

ALUMINIJUM FOAM SLAT
(55mm, 77mm)

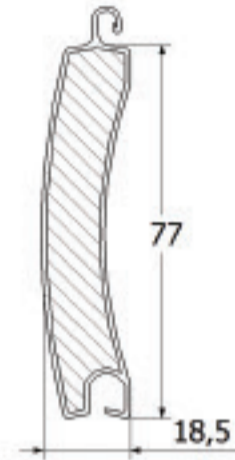
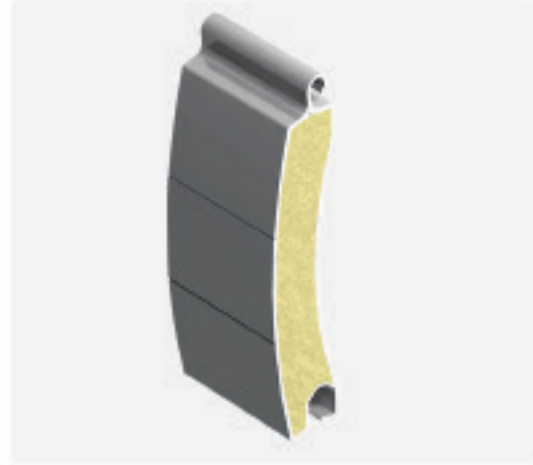

BOX FOR ROLLO DOOR
(300x300; 350x350)

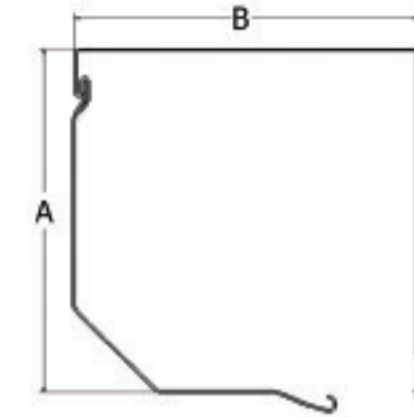

ALUMINIUM EXTRUDED END SLAT
(90x15mm)

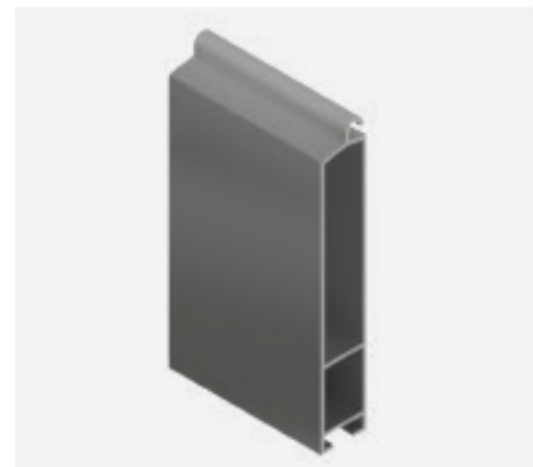

SIDE CAP
(300x300; 350x350)

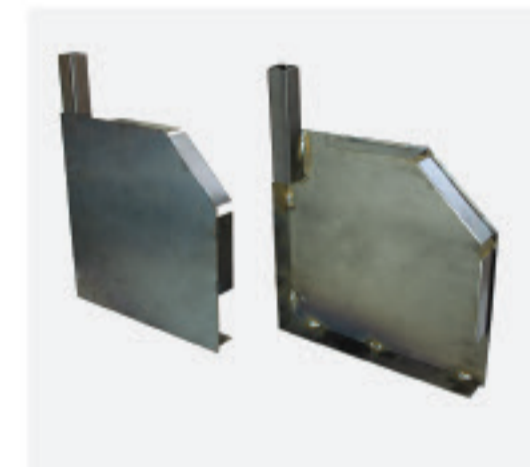

ALUMINIUM EXTRUDED GUIDE CHANNEL
(90x35mm)

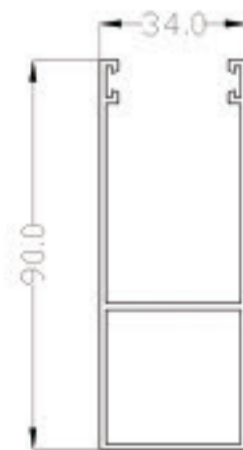

END SLAT RUBBER SEAL



**SECURITY LOCK
WITH A RING**



**ENTRY GUIDE
WITH ROLLER**



**BALL BEARING
STEEL BUSHING
(42x12)**



**BRACKET
(42mm)**



**PLASTIC CAP WITH PIN
(Ø70)**



**ALUMINIUM CAP WITH PIN
(Ø70)**



**PLASTIC SIDE LOCK
(77mm)**



**OCTAGONAL GALVANIZED
STEEL AXEL (Ø70)**

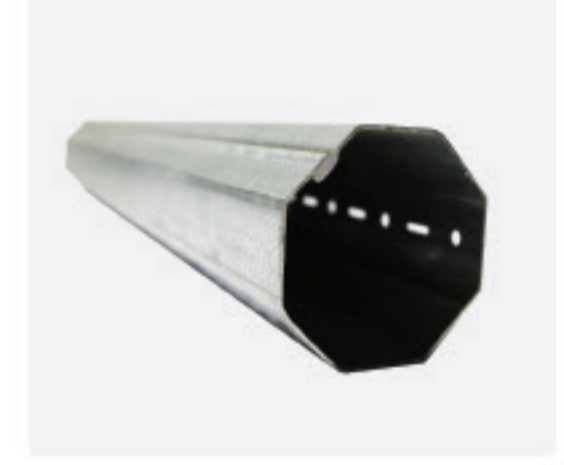



**INSECT
SCREENS**

ROLLER INSECT SCREEN WITH NET
(1.6m; 2.4m)



SCROLLING INSECT SCREEN WITH NET WITH BOTTOM BATTEN
(1.6m; 2.4m)



INSECT SCREEN GUIDE CHANNEL WITH A BRUSH

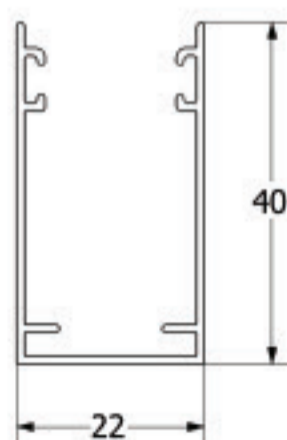

ROLLER INSECT ACCESSORIES SET

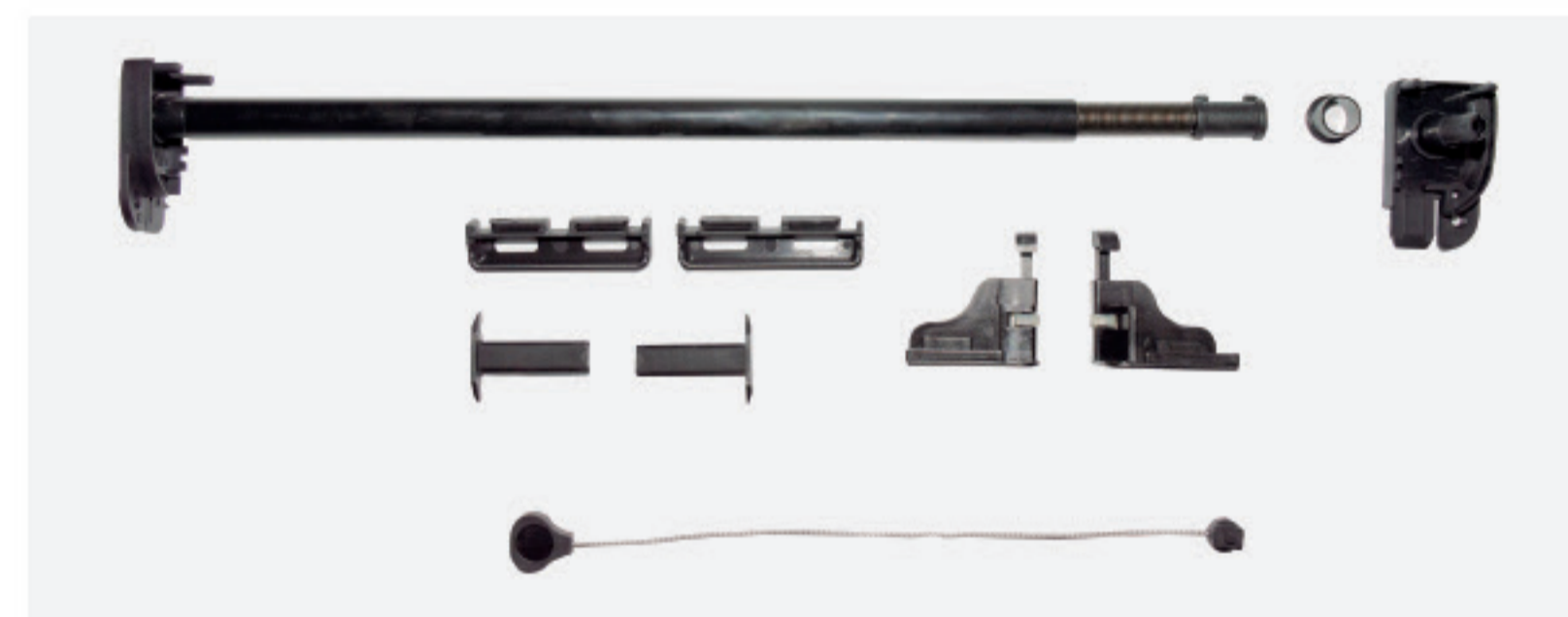

FRAME PROFILE

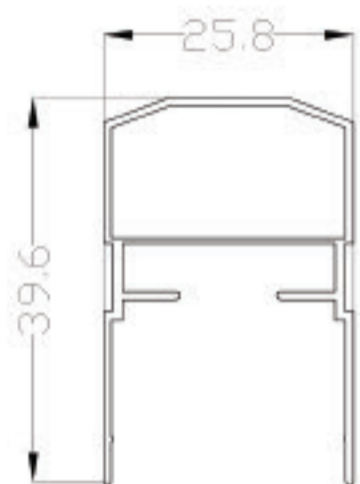
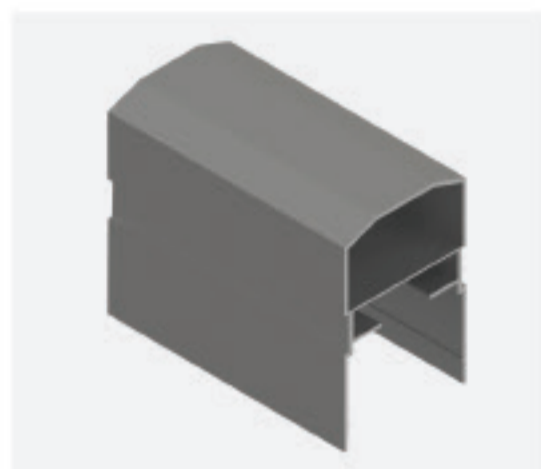

PLEATED MESH (2000mm; 2200mm; 2500mm; 3000mm)

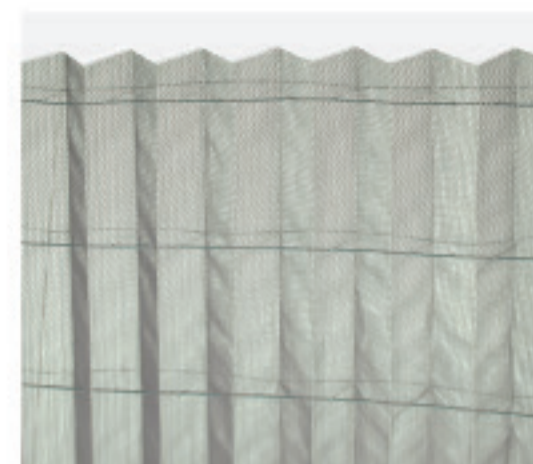

NET FIXING STRIP



SLIDING PROFILE (6m; 6.3m)

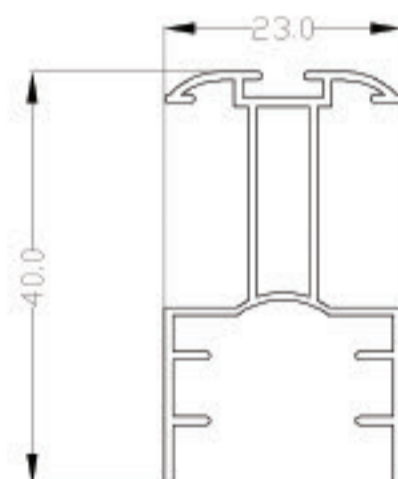
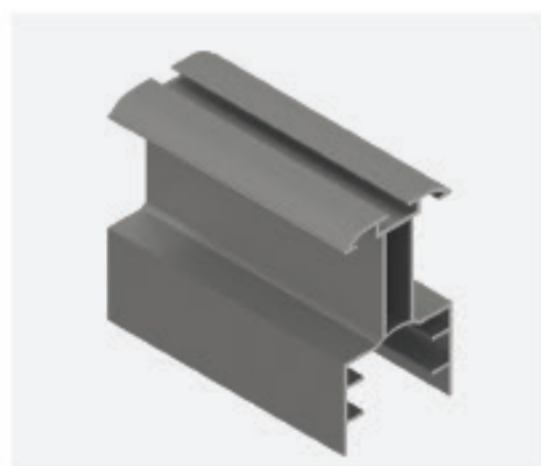

BALANCE WIRE - ROPE (roll 500m)



DOUBLE TAPE (roll 50m)



BOTTOM PROFILE (8mm)

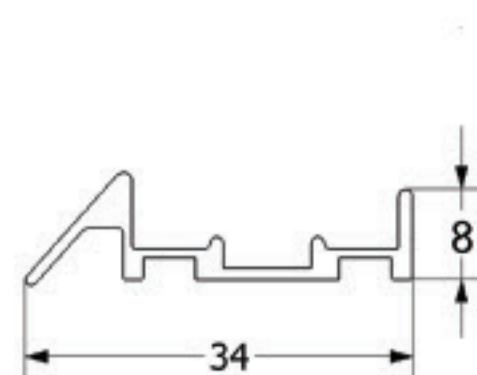
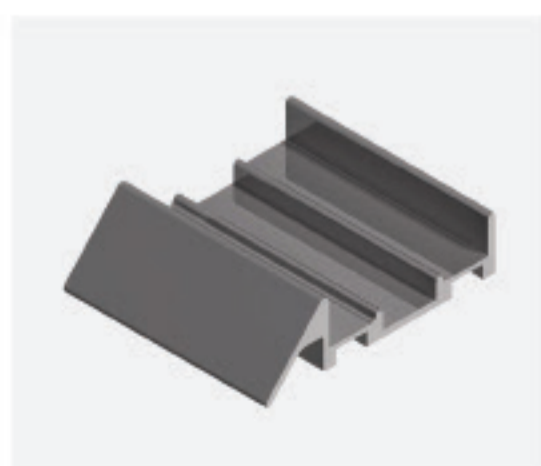

MAGNETICE TAPE (kotur 200m)



HANDLE



PLISSE SET - TAKMATIK



PLISSE SET - TYPE 1



PLISSE SET - 8mm



PLISSE SET - TYPE 2



TAKMATIK PROFILE



TAKMATIK SLIDING PROFILE



BRUSH FOR
TAKMATIK PROFILE



PVC TAPE FOR
TAKMATIK PROFILE



STICKY TAPE
FOR TAKMATIK

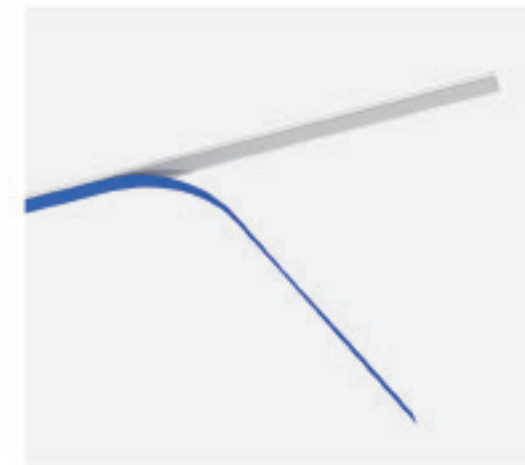





MESH FOR
TAKMATIK PROFILE

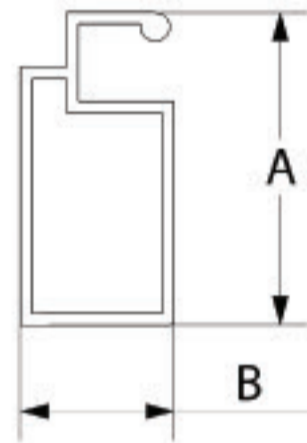
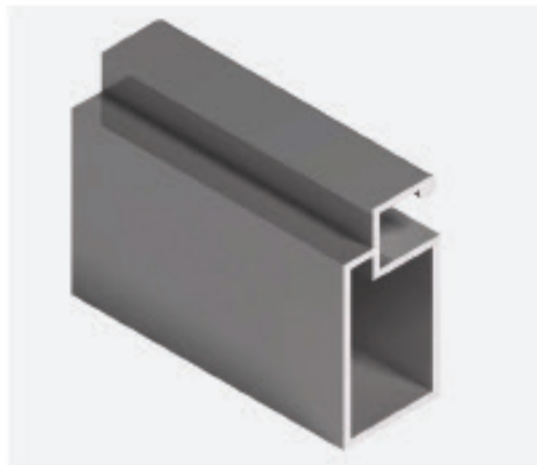

FIXED INSECT SCREEN FRAME
(10x20; 17x25)



-  RAL 9016
-  RAL 9006
-  RAL 8017
-  RAL 8014
-  RAL 7016

FLY NET FIBERGLASS
(1,2x30m; 1,4x30m)



FLY NET FIXING LUG



SMALL HINGE



SMALL CORNER
(90°)

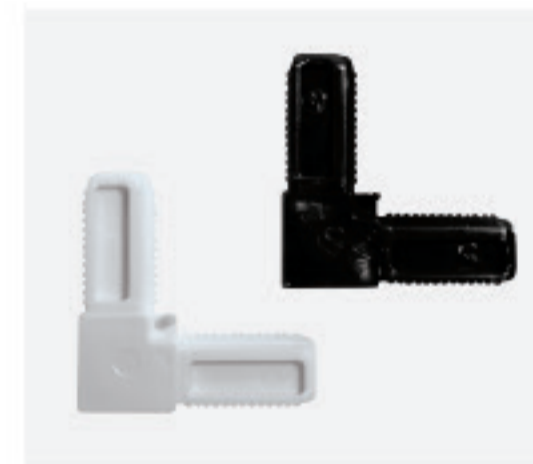

SMALL FASTENER



PVC SMALL CORNER
(45°)



FLY NET CORDON
(5mm)





MOTORS



STANDARD TUBULAR
MOTOR Ø40 10Nm
(AM35-10/14)

STANDARD TUBULAR
MOTOR Ø60 20Nm
(AM45-20/17)

STANDARD TUBULAR
MOTOR Ø70 140Nm
(AM60-140/9)



RADIO MOTOR Ø40 10Nm
(AM35-10/14-E)

RADIO MOTOR Ø60 50Nm
(AM45-50/12-ME)



STANDARD MANUAL OPERATED
TUBULAR MOTOR
Ø60 50Nm (AM45-50/12-M)

STANDARD MANUAL OPERATED
TUBULAR MOTOR
Ø70 80Nm (AM60-80/12-M)

STANDARD MANUAL OPERATED
TUBULAR MOTOR
Ø70 100Nm (AM60-100/12-M)

STANDARD MANUAL OPERATED
TUBULAR MOTOR
Ø70 140Nm (AM60-140/9-M)



EYE OUTLET WITH JOINT



HANDCRANK - FIXED
(1,2m; 1,5m; 2,0m)



HANDCRANK - BRITTLE
(1,2m; 1,5m)



HANDCRANK GEAR SET



CROWN
(70mm)



ADAPTER
(70mm)



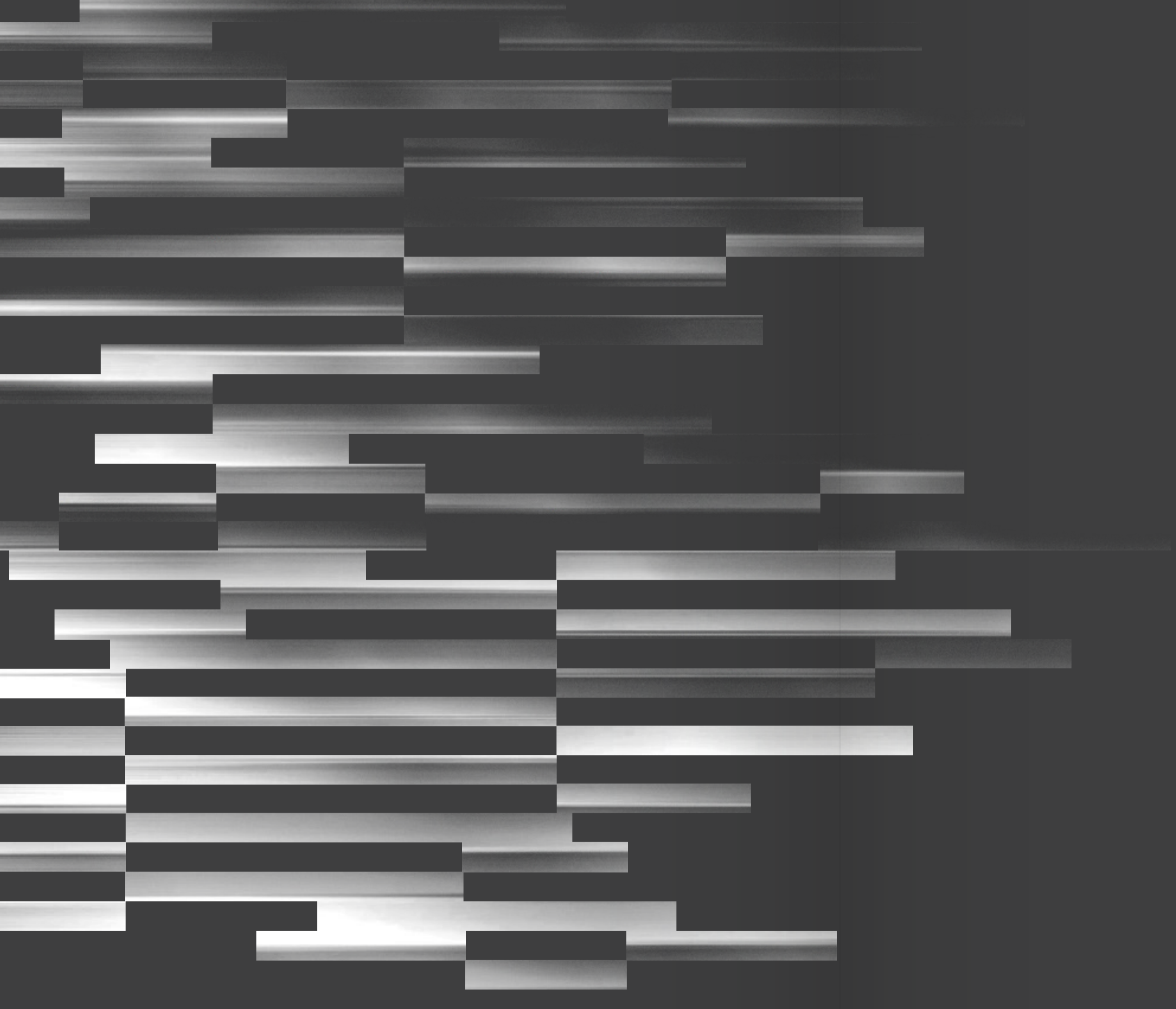

AUTOMATICS

WALL EMITTER
(1 channel)



WALL EMITTER
(2 channels)



PORTABLE EMMITER
(1 channel)



HAND-HELD EMMITER
(1 channel; 6 channels; 16 channels)



RADIO RECEIVER WITH TIMER



MANUAL SWITCH
(1 channel)



PORTABLE EMMITER
(1 channel; 4 channels)



HAND-HELD EMMITER WITH MAGNET HOLDER
(1 channel; 6 channels; 16 channels)



HAND-HELD EMMITER, TOUCH BUTTONS
(1 channel; 2 channels; 6 channels; 16 channels)



RADIO RECEIVER



EXTERNAL TUBULAR MOTOR RECEIVER WITH 2 EMMITERS



RADIO RECEIVER, MINI SIZE, WATERPROOF



PHOTOCELL





